

NearHub Board S Series

USER MANUAL



Please read this manual before use and keep it for backup

SAFETY INSTRUCTIONS

WARNINGS AND PRECAUTIONS

Please note the following safety warning signs

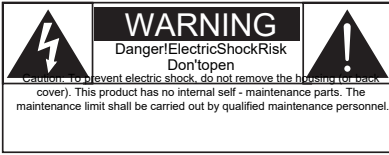

Note: To prevent electric shock, do not remove the enclosure (or back cover). There are no self-maintenance parts in this product. The maintenance limit shall be carried out by qualified maintenance personnel.



This symbol indicates that there is a high voltage inside. Any contact with internal parts of this product is dangerous.



This sign is to remind you that there is important operation and maintenance matters comes with this product.

Note: To prevent electric shock, please fully insert the plug into the socket in the width direction.

To prevent damage from causing fire or electric shock, do not expose the product to rain or a moist environment.

Power sockets should be installed near the product and should be easy to use.



Read and follow these instructions when connecting and using public information displays:

- Unplug the display if you are not going to use it for a long period of time
- If you need to clean the monitor with a damp wipe cloth, remove the plug first. Wipe the screen with a dry cloth only after the power is turned off, but do not use alcohol, solvent or liquid containing ammonia.
- If you have followed the instructions in this manual, but the monitor still cannot work properly, please consult the maintenance technician.
- The cover should only be opened by qualified maintenance personnel.
- Keep the monitor out of direct sunlight and away from stoves or other heat sources.
- Do not let the monitor contact with any oil stains, plastic parts may be aging and crack.
- Remove anything that could fall into the vent or interfere with the heat dissipation of the display electronics.
- Do not block the ventilation holes on the cabinet.
- Keep the monitor dry. In order to avoid electric shock, do not place the product in a humid environment or be exposed to rain.
- If the power cable is directly removed, please wait 6 seconds and then plug the power cable back in to ensure normal operation.
- In order to avoid electric shock and permanent damage to the product, do not place the product in an overly humid environment or be exposed to rain.
- When placing the monitor, ensure that the power plug and socket are easy to use.

Important Safety Instructions

1. Read these instructions. Keep these
2. instructions. Heed all warnings. Follow all
3. instructions. Do not use this apparatus near
4. water. Clean only with dry cloth. Do not block
5. any ventilation openings.
6. Install in accordance with the manufacturer's
7. instructions. Do not install near any heat
8. sources such as radiators, heat registers, stoves, or other apparatus (including amplifiers) that produce heat.
9. Do not defeat the safety purpose of the polarized or grounding-type plug. A polarized plug has two blades, one wider than the other. A grounding type plug has two blades and a third grounding prong. The wide blade or the third prong are provided for your safety. If the provided plug does not fit into your outlet, consult an electrician for replacement of the obsolete outlet.
10. Protect the power cord from being walked on or pinched particularly at plugs, convenience receptacles, and the point where they exit from the apparatus.
11. Only use attachments/accessories specified by the manufacturer.
12. Use only with the cart, stand, tripod, bracket, or table specified by the manufacturer, or sold with the apparatus. When a cart is used, use caution when moving the cart/apparatus combination to avoid injury from tip-over. Use with other (carts, stands, or carriers) may result in instability causing injury.
13. Unplug this apparatus during lightning storms or when unused for long periods.
14. Refer all servicing to qualified service personnel. Servicing is required when the apparatus has been damaged in any way, such as if the power-supply cord or plug is damaged, liquid has been spilled or objects have fallen into the apparatus, the apparatus has been exposed to rain or moisture, does not operate normally, or has been dropped.



WARNING: To reduce the risk of fire or electric shock, do not expose the product to rain or moisture.

WARNING: Do not place the product in a dripping or splashing environment. Do not place containers containing liquids (such as vases) above the product.

WARNING: Do not expose the battery (installed battery) to overheating temperature, such as sunshine, flame, etc.

WARNING: The power plug or electrical coupler is used as a power outage device, and the power outage device should be kept operational at all times.

WARNING: To avoid being affected by heat, please keep the product away from candles or other open flames.



WARNING: To prevent personal injury, the product shall follow the installation instructions the indicator is fixed on the floor/wall.

NOTE: These maintenance instructions are for the use of qualified maintenance personnel only. In order to reduce the risk of electric shock, all maintenance actions other than those indicated should be handled by qualified personnel.

NOTE: Excessive voice pressure in earphones and earmuffs may cause hearing loss. When the equalizer is set to the highest level, the output voltage and sound pressure intensity of the earphone and ear tube will be increased. Therefore, to protect your hearing, please adjust the equalizer to the appropriate position.

WARNING: Do not put the marker near electronic medical devices or people carrying medical devices such as pacemakers.

This equipment is compliant with **WARNING:** Class A of EN55032/CISPR 32. In a residential environment this equipment may cause radio interference.

This equipment has been tested and found to comply with the limits for a Class A digital device, pursuant to part 15 of the FCC Rules. These limits are designed to provide reasonable protection against harmful interference **NOTE:**

when the equipment is operated in a commercial environment. This equipment generates, uses, and can radiate radio frequency energy and, if not installed and used in accordance with the instruction manual, may cause harmful interference to radio communications. Operation of this equipment in a residential area is likely to cause harmful interference in which case the user will be required to correct the interference at his own expense.

Helpful hints

1. If you find that the glass surface is stained during use, you can use the following ways to deal with it. You can use wet wipes (to avoid dripping) to wipe it once, and then dry towels (or dry paper towels) to wipe it clean.

0 ~5

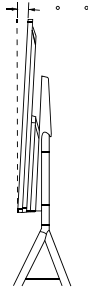

2. Leaning forward will affect the touch effect. It is recommended to install the product at a backward Angle of 0° to 5°.

Stability Hazard.

The product may fall, causing serious personal injury or death. To prevent injury, this product must be securely attached to the floor/wall in accordance with the installation instructions.

Disposal of products after expiration of service life

Your new public information display contains recyclable and reusable materials. There are specialized companies that can recycle the product and use the reusable materials in it to reduce the amount of waste thrown away.

Check with your local distributor for local laws and regulations regarding the disposal of your old monitor.

Waste Electrical and Electronic Equipment-WEEE

Attention users in European Union private households



This marking on the product or on its packaging illustrates that, under European Directive 2012/19/EU governing used electrical and electronic appliances, this product may not be disposed of with normal household waste. You are responsible for disposal of this equipment through a designated waste electrical and electronic equipment collection. To determine the locations for dropping off such waste electrical and electronic, contact your local government office, the waste disposal organization that serves your household or the store at which you purchased the product.

Attention users in United States:

Please dispose of according to all Local, State and Federal Laws. For the disposal or recycling information, contact: www.mygreenelectronics.com or www.eiae.org.

End of Life Directives-Recycling



Your new Public Information Display contains several materials that can be recycled for new users.

Please dispose of according to all Local, State, and Federal laws.

EU Declaration of Conformity

This device complies with the requirements set out in the Council Directive on the Approximation of the Laws of the Member States relating to Electromagnetic Compatibility (2014/30/EU), Low-voltage Directive (2014/35/EU), RoHS Directive (2011/65/EU), ErP Directive (2009/125/EC)(Regulation (EU) 2019/2021).

This product has been tested and found to comply with the harmonized standards for Information Technology Equipment, these harmonized standards published under Directives of Official Journal of the European Union.

Polish Center for Testing and Certification Notice

The equipment should draw power from a socket with an attached protection circuit (a three-prong socket). All equipment that works together (computer, display, printer, and so on) should have the same power supply source.

The phasing conductor of the room's electrical installation should have a reserve short-circuit protection device in the form of a fuse with a nominal value no larger than 16 amperes (A).

To completely switch off the equipment, the power supply cable must be removed from the power supply socket, which should be located near the equipment and easily accessible.

A protection mark "B" confirms that the equipment is in compliance with the protection usage requirements of standards PN-93/T-42107 and PN-89/E-06251.

This device complies with Part 15 of the FCC / ISSED's licence-exempt RSSs Rules. Operation is subject to the following two conditions: (1) This device may not cause harmful interference, and (2) this device must accept any interference received, including interference that may cause undesired operation.

Le présent appareil est conforme aux CNR d' ISSED applicables aux appareils radio exempts de licence. L'exploitation est autorisée aux deux conditions suivantes : (1) le dispositif ne doit pas produire de brouillage préjudiciable, et (2) ce dispositif doit accepter tout brouillage reçu, y compris un brouillage susceptible de provoquer un fonctionnement indésirable.

FCC/ISED/CE-RED Caution:

Any changes or modifications not expressly approved by the party responsible for compliance could void the user's authority to operate this equipment. This transmitter must not be co-located or operating in conjunction with any other antenna or transmitter. Operations in the 5GHz products are restricted to indoor usage only.

Radiation Exposure Statement:

This equipment complies with FCC/ISED/CE-RED radiation exposure limits set forth for an uncontrolled environment.

This equipment should be installed and operated with minimum distance 20cm between the radiator & your body.

Déclaration d'exposition aux radiations:

Cet équipement est conforme aux limites d'exposition aux rayonnements ISED établies pour un environnement non contrôlé.

Cet équipement doit être installé et utilisé avec un minimum de 20cm de distance entre la source de rayonnement et votre corps.

EU Declaration of Conformity / UK Declaration of Conformity

This device complies with the essential requirements of the Radio Equipment Directive (2014/53/EU) or Radio Equipment Regulations 2017 (for UK).

The following test methods have been applied in order to prove presumption of conformity with the essential requirements of the Radio Equipment Directive

Radiation Exposure Statement:

This equipment complies with CE radiation exposure limits set forth for an uncontrolled environment. This equipment should be installed and operated with minimum distance 20cm between the radiator & body.

The frequency, mode and the maximum transmitted power are listed below:

- 2400-2483.5MHz: < 20 dBm (EIRP) (for 2.4G product only)
- 5150-5250MHz: < 23 dBm (EIRP)
- 5250-5350MHz: < 23 dBm (EIRP)
- 5470-5725MHz: < 30 dBm (EIRP)
- 5725-5875MHz: < 13.98 dBm (EIRP)

The device is restricted to indoor use only when operating in the 5150 to 5350MHz frequency range. (for 5G product only)

	AT	BE	BG	HR	CY	CZ	DK
	EE	FI	FR	DE	EL	HU	IE
	IT	LV	LT	LU	MT	NL	PL
	PT	RO	SK	SI	ES	SE	UK(NI)
	UK						

Batteries



For EU: The crossed-out wheeled bin implies that used batteries should not be put to the general household waste! There is a separate collection system for used batteries, to allow proper treatment and recycling in accordance with legislation. Please contact your local authority for details on the collection and recycling schemes. For Switzerland: The used battery is to be returned to the selling point. For other non-EU countries: Please contact your local authority for correct method

of disposal of the used battery.

According to EU directive 2006/66/EC, the battery can't be disposed improperly. The battery shall be separated to collect by local service.



Após o uso, as pilhas e/ou baterias deverão ser entregues ao estabelecimento comercial ou rede de assistência técnica autorizada.

目录

1. Unboxing and installation	6
2. Components and functions	8
3. Connecting external devices	9
4. Touch operation	11
5. Cleaning and troubleshooting	12
6. Technical specifications	14

This manual is for reference only, please refer to the actual machine.

1. Unboxing and installation

1.1. Unboxing

- •The product is packed in a carton with standard accessories.
Any other optional accessories will be packed separately.
Considering the size and weight of this monitor, it is recommended that two people carry this monitor.
After opening the box, please verify that all parts are included and in good condition.

1.2. The contents of the packing case

Please confirm that the following items are included in the packing box:

- Display
- User manual
- Warranty card
- The power cord
- Stylus pen
- Screw accessory kit



* The attached power cord varies by sales region.



User manual



Warranty card



The power cord



Stylus pen



Screw accessory kit

Note:

- For all other areas, the power cord used should match the AC voltage of the power outlet, comply with the relevant safety regulations of the country/region and be certified.
- You can keep the packing box and packing materials for future transportation of the monitor

1.3. Precautions for installation

- Due to the high power consumption, always use the plug exclusively designed for this product. If an extended line is required, please consult your service agent
- The product should be installed on a flat surface to avoid tipping. The distance between the back of the product and the wall should be maintained for proper ventilation. Avoid installing the product in the kitchen, bathroom or any other places with high humidity to avoid shortening the service life of the electronic components.
- The product can normally only operate under 5000m in altitude. If above 5000m, there may be something unexpected occur

1.4. Hang it on the wall

To mount this monitor to a wall, the standard wall-mount kit is recommended. We recommend that you use assembly boards that meet **TUV-GS** and/or **UL1678** standards.

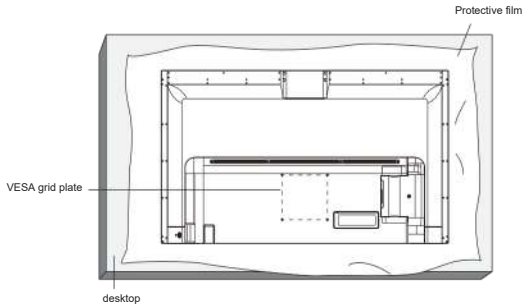

1. Lay the protective film (which wraps around the monitor when packing) on the table, placing the monitor face down on the protective film to avoid scratching the surface of the screen.
2. Make sure you have all the accessories you need to install this monitor (wall rack, lifting rack, desktop base, etc.).
3. Follow the instructions that came with the base assembly kit. Failure to follow the correct assembly steps may result in damage to the equipment or injury to the user or installer. The product warranty does not cover damage caused by improper installation.
4. For the wall mount kit, use the **M6** assembly screw (the length exceeds the thickness of the assembly frame by **10 mm**) and tighten the screw.

1.4.1. VESA grid plate

200(H) x 200(V) mm

Be careful:

Prevent the display from falling:

- For wall-hanging or hoisting cases, we recommend the use of commercially available metal assembly racks for mounting the monitor. For detailed installation instructions, see the guide that came with the assembly rack.
- To reduce the possibility of the display falling and causing injury and property damage in the event of an earthquake or other natural disaster, consult the assembly rack manufacturer to confirm the installation location.

Ventilation requirements for enclosed Spaces

For normal heat dissipation, sufficient space should be left between the surrounding items, as shown in the figure below.

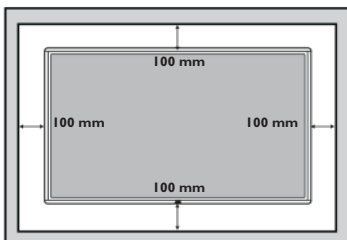

2. Components and functions

2.1. Input/Output Interface

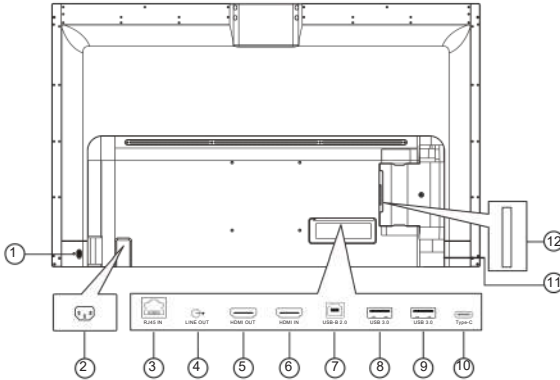

① OK / Power

Turn the power on or off.

② AC Input

AC power input from wall sockets.

③ RJ45 IN

Wired network connection.

④ LINE OUT

Output audio to an external AV device.

⑤ HDMI OUT

HDMI Video/audio output.

⑥ HDMI IN

HDMI Video/audio input.

⑦ USB-B 2.0

Connect the touch control of the PC.

⑧ USB 3.0

Connect the USB storage device.

⑩ Type-C

USB storage device connected to TYPE-C interface

⑪ USB 2.0

Connect the USB storage device.

⑫ OPS

Connect the OPS device.

WARNING: The additional equipment that connect to OPS ports are as requiring a fire enclosure.

2.2. Stylus Pen

The pen can be adsorbed to the rear iron backplane position (as shown)

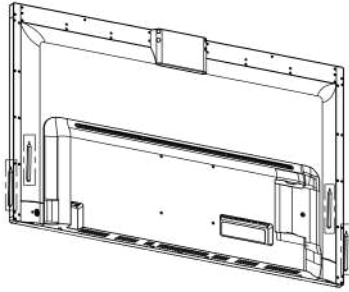

It is adsorbed on both sides of the frame or the rear iron back plate

3. Connecting external devices

3.1. Connect to external devices

3.1.1. Use HDMI video input

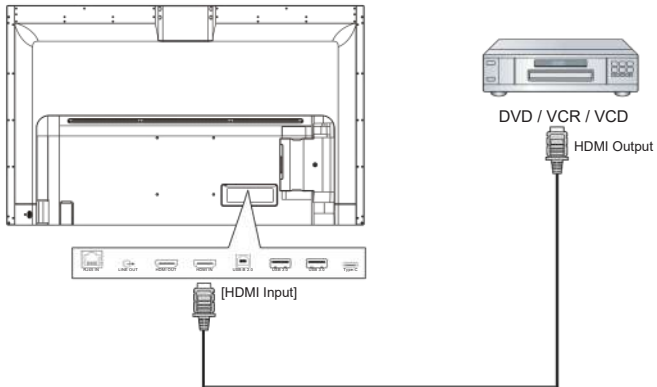

3.2. Connect to PC

3.2.1. Use HDMI Input

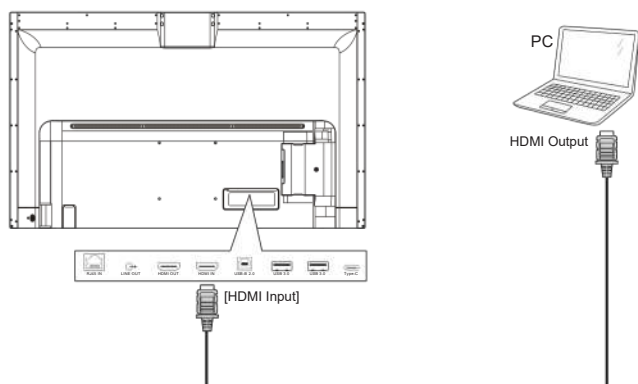

3.3. Surf the Internet

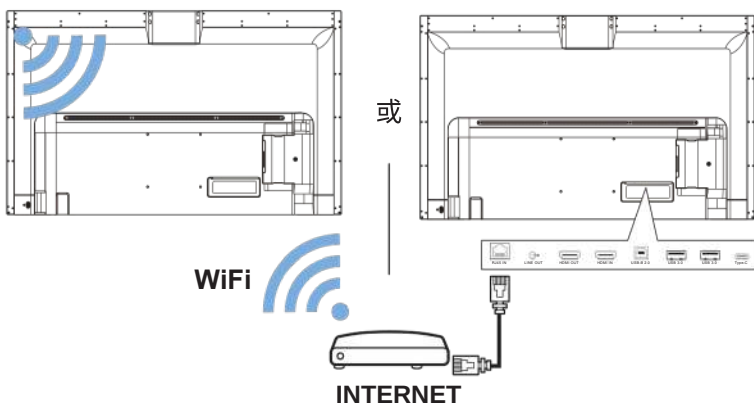

3.4. Connecting audio devices

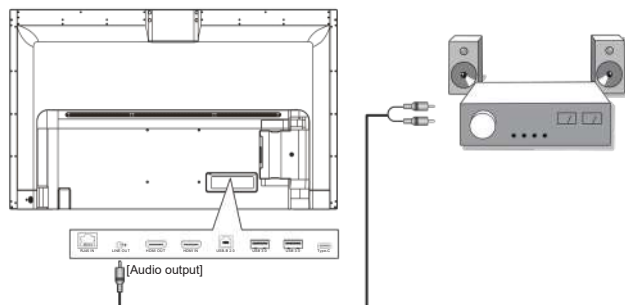

3.5. Connect the USB

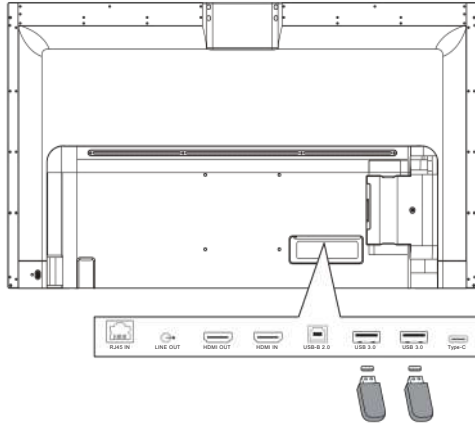

3.6. Connect the OPS

Insert the OPS, adjust and lock the small iron piece, and then lock the OPS.

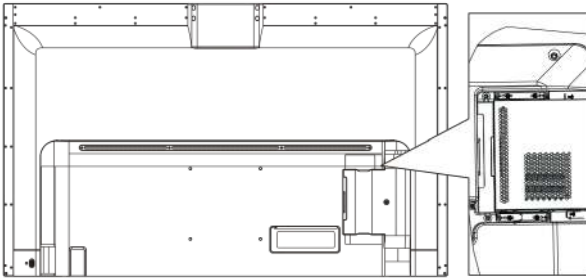

4. Touch operation

- Avoid scraping the screen with sharp objects. You can use the attached stylus to touch.
- Do not expose the screen to bright light, spotlights or floodlights.
- Do not install the product near Windows or glass doors, otherwise direct sunlight may affect the touch effect.
- To avoid interference between the screens, do not place the two touch screens side by side, as shown below.

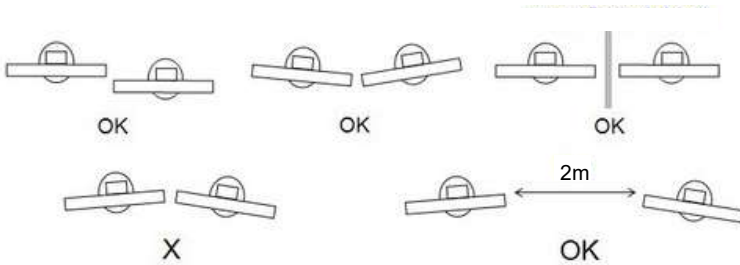

5. Cleaning and troubleshooting

5.1. Cleaning

Caution when using the display

- Do not bring your hands, face or objects close to the ventilation holes of the display. The top of the display is usually very hot due to the high temperature of exhaust air being released through the ventilation holes. Burns or personal injuries may occur if any body parts are brought too close. Placing any object near the top of the display could also result in heat-related damage to the object as well as the display itself.
- Be sure to disconnect all cables before moving the display. Moving the display with its cables attached may damage the cables and thus cause fire or electric shock.
- Disconnect the power plug from the wall outlet as a safety precaution before carrying out any type of cleaning or maintenance procedure.

Front panel cleaning instructions

- The front of the display has been specially treated. Wipe the surface gently using only a cleaning cloth or a soft, lint-free cloth.
- If the surface becomes dirty, soak a soft, lint-free cloth in a mild detergent solution. Wring the cloth to remove excess liquid. Wipe the surface of the display to remove dirt. Then use a dry cloth of the same type to dry.
- Do not scratch or hit the surface of the panel with fingers or hard objects of any kind.
- Do not use vaporous substances such as insert sprays, solvents and thinners.

Back panel cleaning instructions

- If the cabinet becomes dirty, wipe the cabinet with a soft, dry cloth.
- If the cabinet is extremely dirty, soak a lint-free cloth in a mild detergent solution. Wring the cloth to remove as much moisture as possible. Wipe the cabinet. Use another dry cloth to wipe over until the surface is dry.
- Do not use any solution containing grease to clean plastic parts. Plastic parts may be aged and cracked when exposed to grease.
- Do not allow any water or detergent to come into contact with the surface of the display. If water or moisture gets inside the unit, operating problems and electrical and shock hazards may result.
- Do not scratch or hit the cabinet with fingers or hard objects of any kind.
- Do not use corrosive substances such as insert sprays, solvents and thinners on the cabinet.
- Do not place anything made from rubber or pvc near the cabinet for extended periods of time.

5.2. Troubleshooting

Abnormal situation	Possible causes	The solution
No screen display	<ol style="list-style-type: none"> 1. The power cord has been disconnected. 2. The main power switch on the back of the monitor is not open. 3. The selected input is not connected. 4. The monitor is in standby mode. 	<ol style="list-style-type: none"> 1. Plug in the power cord. 2. Make sure the power switch is on. 3. Connect the signal to the display.
Interference or noise can be heard on the monitor	Caused by surrounding electrical equipment or fluorescent lighting	Move the display to another location to see if the interference can be reduced.
The color is not normal.	The signal line is not properly connected.	Make sure the signal cable is securely connected to the back of the monitor.
The picture is distorted and has abnormal patterns	<ol style="list-style-type: none"> 1. The signal line is not properly connected. 2. The input signal exceeds the ability of the display. 	<ol style="list-style-type: none"> 1. Ensure that the signal line is firmly connected. 2. Check the video source to see if it is out of range of the display. Please check the specifications against the technical specifications section of this monitor.
Sounds can be heard, but there is no picture	The input source signal line is not connected correctly.	Make sure the video input and sound input are connected correctly.
You can see the picture but you can't hear the sound	<ol style="list-style-type: none"> 1. The input source signal line is not connected correctly. 2. The volume is at a minimum. 3. {Mute} is enabled. 4. No external speakers connected. 	<ol style="list-style-type: none"> 1. Make sure the video input and sound input are properly connected. 2. Adjust the volume using the [+] or [-] buttons. 3. Use the [] button to turn off silence. 4. Connect external speakers and turn the volume to the appropriate level.
Some of the elements don't light up	Some pixels on the screen may not be active.	This display is manufactured with very high precision technology, however, there are times when some pixels on the display may still not be displayed. This is not a failure.
After the power off of the monitor, the image residue still appears on the monitor screen. (Examples of still images include logos, video games, computer images, and images displayed in 4:3 standard mode.)	The display time of the still picture is too long	Do not allow static images to be displayed for too long, or permanent image residue will appear on the monitor.